

Feature

- § Low Power Consumption
- § High Intensity
- § I.C. compatible

Applications

- § Commercial Outdoor Sign Board
- § Front Panel Indicator
- § Dot-Matrix Module
- § LED Bulb

Description

- § These High Intensity LEDs are Based on InGaN/Sapphire Material Technology
- § Water Transparent Lens

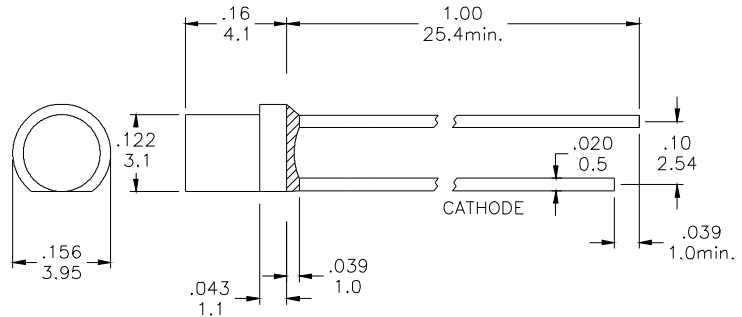
Package Dimension

*Tolerance : $\pm \frac{0.01}{0.25}$ Unit : $\pm \frac{\text{inch}}{\text{mm}}$

Absolute Maximum Ratings at Ta = 25°C

Symbol	Parameter	Max.	Unit
PD	Power Dissipation	120	mW
VR	Reverse Voltage	5	V
IAF	Average Forward Current	40	mA
IPF	Peak Forward Current (Duty=0.1, 1kHz)	100	mA
—	Derating Linear Form 25°C	0.4	mA / °C
Topr	Operating Temperature Range	- 40 to + 80	°C
Tstg	Storage Temperature Range	- 40 to + 100	°C
Lead Soldering Temperature [1.6mm (0.063inch) From Body] 260°C For 5 Seconds.			

Electrical / Optical Characteristics and Curves at Ta = 25°C

Symbol	Parameter	Test Condition	Min.	Typ.	Max.	Unit
VF	Forward Voltage	IF = 20 mA		3.5	4.0	V
IR	Reverse Current	VR = 5 V			50	μA
$\Delta \theta$	Half Intensity Angle	IF = 20 mA		110		Deg.
IV	Luminous Intensity	IF = 20 mA		450		mcd.
λd	Dominant Wavelength	IF = 20 mA	510	515	520	nm



Electrical Characteristics at Ta = 25°C

Symbol	I _v		V _F		λ D	
Parameter	Luminous Intensity		Forward Voltage		Dominant Wavelength	
Condition	IF=20mA		IF=20mA		IF=20mA	
Unit	mcd		V		nm	
Binning	Grade	Range	Grade	Range	Grade	Range
	BIN 13	345~485	P1	3.0~3.2	G17	510~515
	BIN 14	485~680	P2	3.2~3.4	G18	515~520
			P3	3.4~3.6		
			P4	3.6~3.8		
			P5	3.8~4.0		

Intensity: Tolerance of minimum and maximum = ± 15%

V_f: Tolerance of minimum and maximum = ± 0.05v

NOTE:

1. Static electricity and surge damages the LED. It is recommend to use a anti-static wrist band or anti-electrostatic glove when handing the LEDs. All devices, equipment and machinery must be properly grounded.

Radiation Diagram

IF=20 mA 50% Power Angle Angle =110°

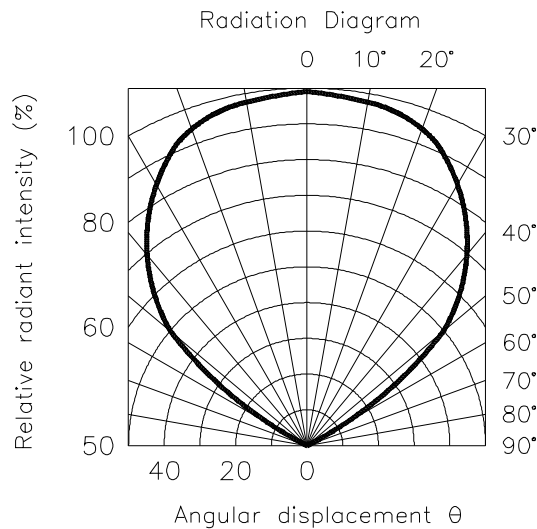



Forward Current
Vs. Ambient Temperature

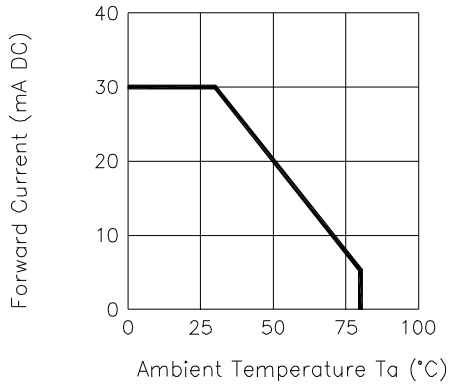

Forward Current
Vs. Forward Voltage

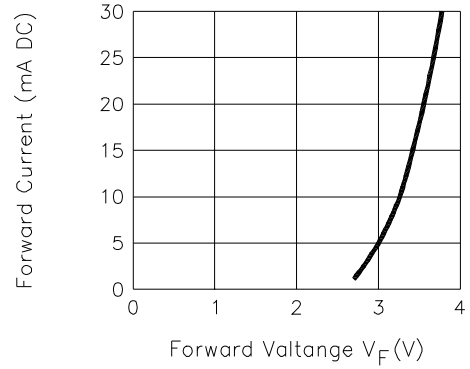

Relative Intensity
Vs. Forward Current

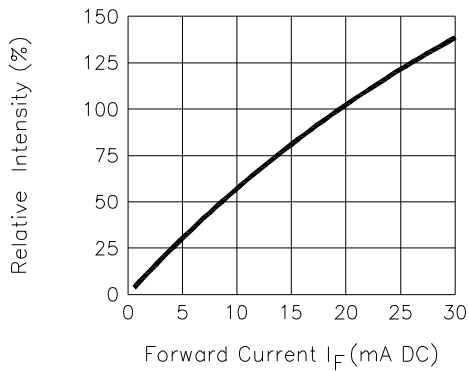

Relative Intensity
Vs. Lead Temperature
(Pulsed 20 mA; 300us pulse,
10ms period)

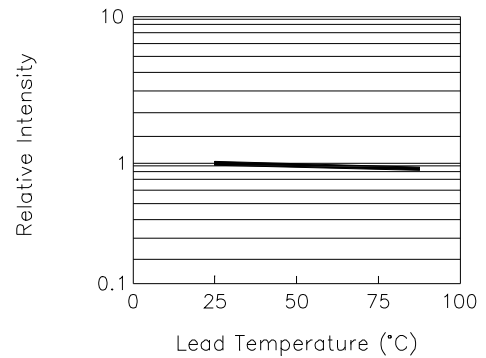

Relative Intensity Vs. Wavelength

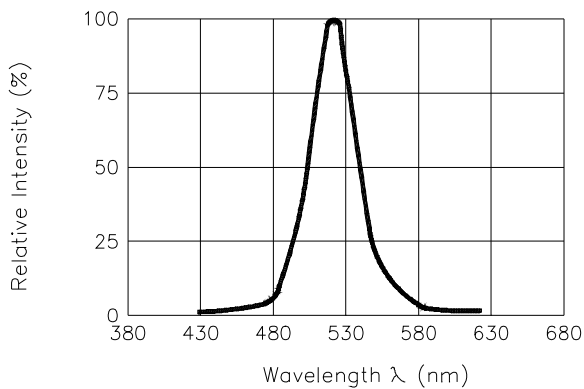

Peak Forward Voltage
Vs. Forward Current
(100us test pulse,
1% duty cycle)

